

# AR326B (Flush Bolt)

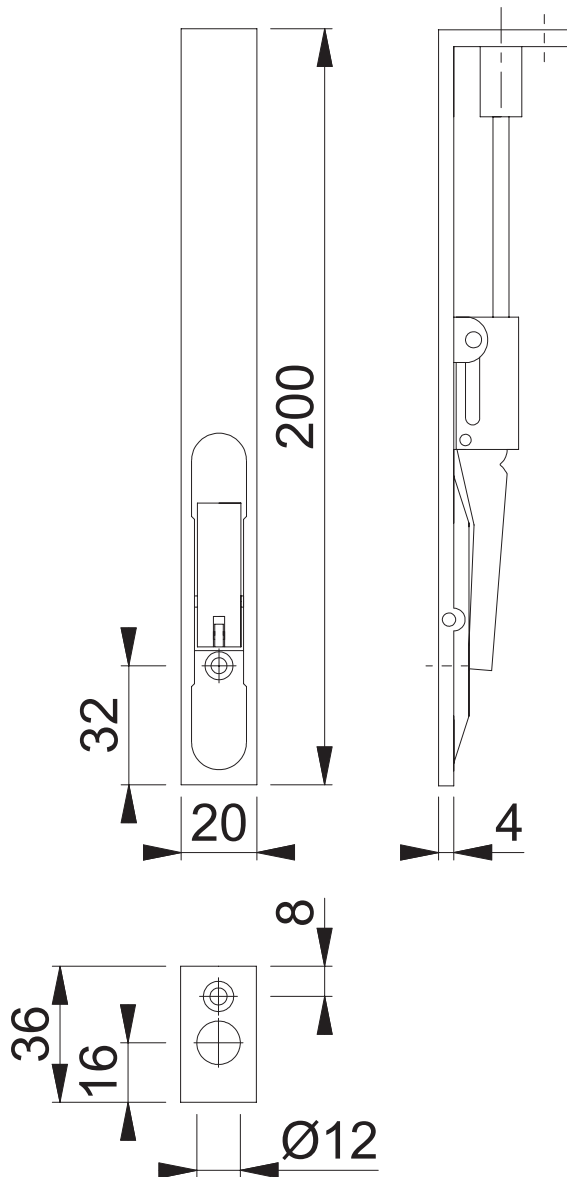

These documents are property of HOPPE (UK), Wolverhampton and are protected by both copyright and fair trade law. Any reproduction, reprint, copying, passing on to third parties and whichever use of these documents or parts thereof is prohibited, except with prior written consent of HOPPE.

Scale  
1:2

Name  
J. Renhard

Date  
26.03.15

Drawing No:

c1612005g001

**ARRONE**  
The Complete Range